

Codice F3939X7

MISCELATORE TERMOSTATICO INCASSO CON DEVIATORE A 2 O 3 USCITE

- solo parte esterna
- deviatore a 2/3 uscite
- **corpo incasso da ordinare separatamente**

IMMAGINE



Vedere le condizioni generali di vendita presenti sul nostro
listino in vigore

Finiture

-  CROMO
CR
-  HL
-  HS
-  ZL
-  ZS
-  NICKEL SPAZZOLATO
SN
-  CROMO NERO
CN
-  CROMO NERO SPAZZOLATO
CS
-  BIANCO OPACO
BS
-  NERO OPACO
NS
-  ORO
OR
-  ORO SPAZZOLATO
OS

PRODOTTI DA ORDINARE SEPARATAMENTE

Corpo da incasso



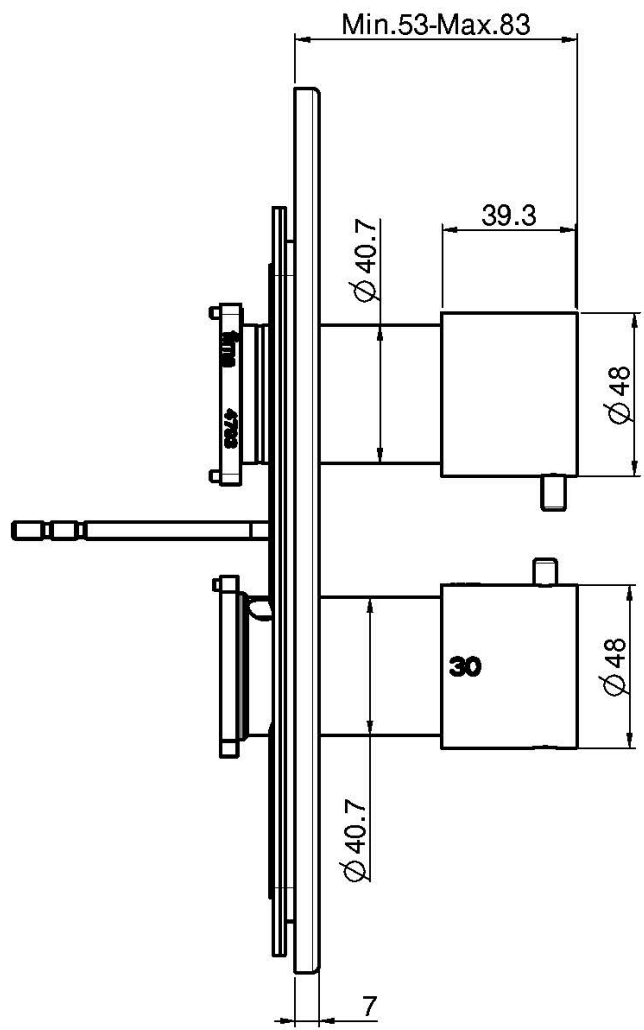
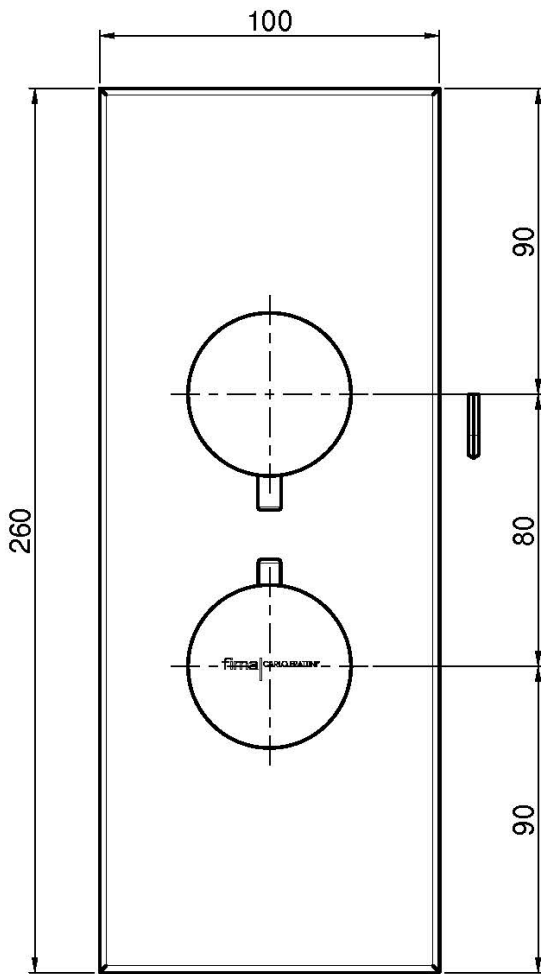

This drawing is the property of FIMA Carlo Frattini. Any complete or partial reproduction, or any transmission to third party without FIMA Carlo Frattini authorization is forbidden.

