

Codice F3939X7

## MISCELATORE TERMOSTATICO INCASSO CON DEVIATORE A 2 O 3 USCITE

- solo parte esterna
- deviatore a 2/3 uscite
- **corpo incasso da ordinare separatamente**

### IMMAGINE



Vedere le condizioni generali di vendita presenti sul nostro  
listino in vigore

### Finiture

-  CROMO  
CR
-  HL
-  HS
-  ZL
-  ZS
-  NICKEL SPAZZOLATO  
SN
-  CROMO NERO  
CN
-  CROMO NERO SPAZZOLATO  
CS
-  BIANCO OPACO  
BS
-  NERO OPACO  
NS
-  ORO  
OR
-  ORO SPAZZOLATO  
OS

### PRODOTTI DA ORDINARE SEPARATAMENTE

#### Corpo da incasso



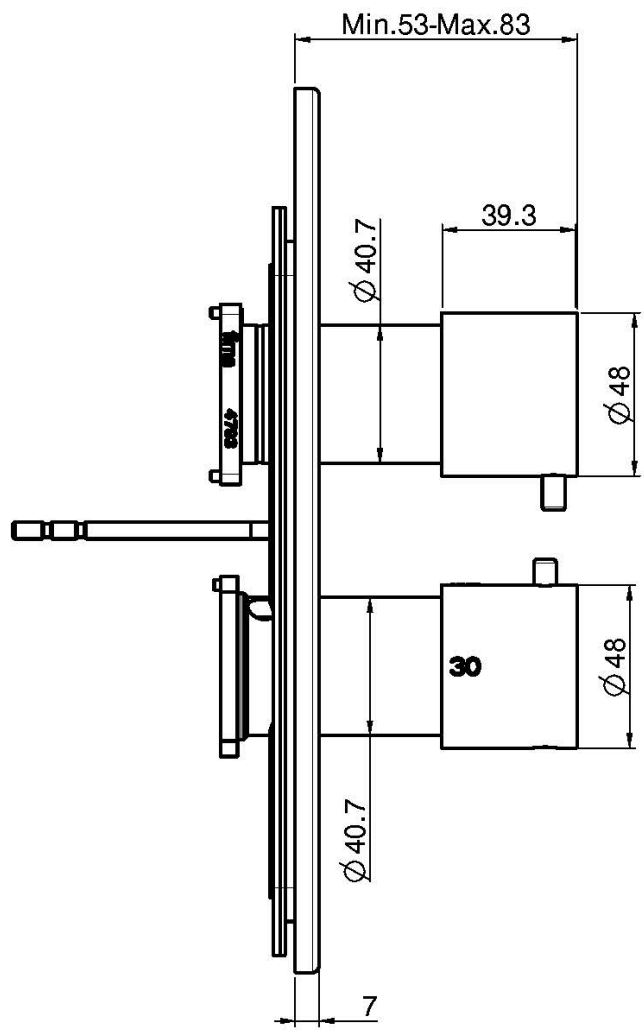
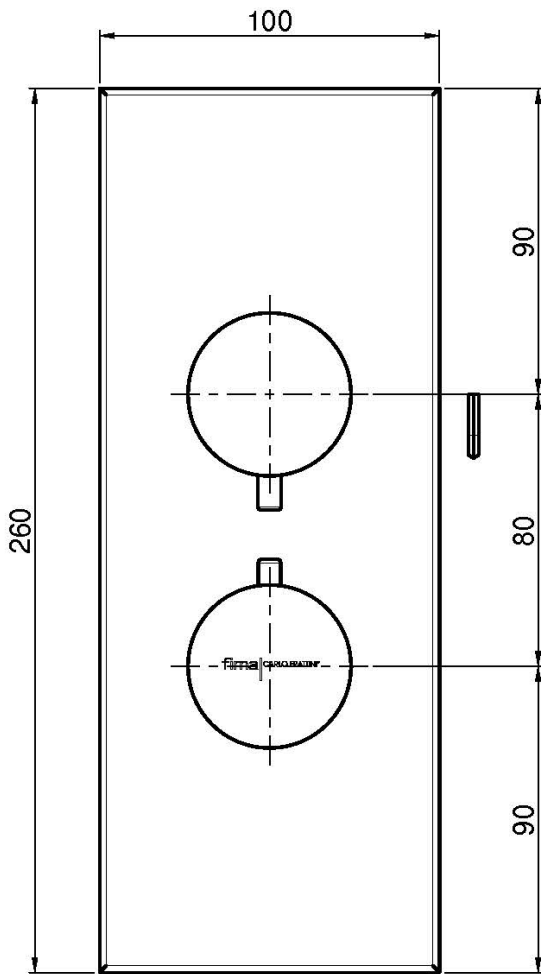

This drawing is the property of FIMA Carlo Frattini. Any complete or partial reproduction, or any transmission to third party without FIMA Carlo Frattini authorization is forbidden.

